

# POLYWOOD

## Assembly Instructions



### L1D84, L1R84, L1B84

### For Use With Rectangle Plank Tables-PL84



### 20-year warranty

View our full warranty:  
[polywoodoutdoor.com/warranty](https://polywoodoutdoor.com/warranty)



### Having trouble?

If you have questions or concerns regarding assembly instructions or missing parts, please contact us at [hello@polywoodoutdoor.com](mailto:hello@polywoodoutdoor.com) or (833) 665-6300



### Cleaning tips

#### For a Quick Clean:

Simply wipe down with soap and water.

#### For a Deep Clean:

Wipe on  $\frac{1}{3}$  bleach and  $\frac{2}{3}$  water solution with a clean cloth and let it sit on the lumber for a few minutes (this will not affect the color). Then, loosen any dirt and debris that may catch in surface grooves with a soft bristle brush; hose down to rinse.

#### For a High-Power Clean:

Use a pressure power washer (not exceeding 1,500 psi) to spray off dirt and debris. Apply a  $\frac{1}{3}$  bleach and  $\frac{2}{3}$  water solution and scrub with a soft-bristle brush. Hose down to rinse.

# Thank You

Thank you for choosing POLYWOOD!  
We hope our furniture helps create a gathering place for you and your loved ones to enjoy for many years to come!



### Reach Out

Let us know how we're doing:  
[hello@polywoodoutdoor.com](mailto:hello@polywoodoutdoor.com)  
(833) 665-6300



### Stay Connected

Be the first to hear about new products, giveaways, and more by signing up for our email list: [polywoodoutdoor.com/subscribe](https://polywoodoutdoor.com/subscribe)



### Watch & Learn

For assembly tips and videos visit:  
[polywoodoutdoor.com/assembly](https://polywoodoutdoor.com/assembly)

### Share your space

We love to see where our furniture ends up — snap a pic and tag it on Instagram or Facebook for your chance to be featured on our social channels!  
**#polywood #rethinkoutdoor**



[facebook.com/polywoodoutdoor](https://facebook.com/polywoodoutdoor)



[@POLYWOOD](https://www.instagram.com/POLYWOOD)



[pinterest.com/polywood](https://pinterest.com/polywood)



[youtube.com/polywood](https://youtube.com/polywood)

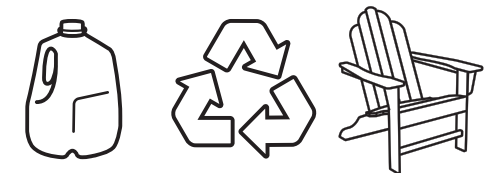

### Did you know?

POLYWOOD was the original outdoor furniture made from recycled materials.

Learn more about our story:  
[genuinePOLYWOOD.com](https://genuinePOLYWOOD.com)

## TOOLS



3/8" wrench  
(not included)



4mm T-handle  
hex key (included)

## PARTS

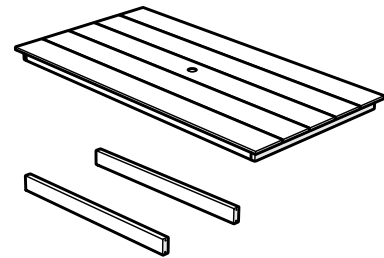

Separate box

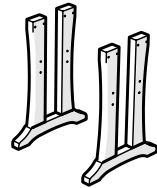

**A** x 8



3" Screw — HHW14X3

**B** x 8



3" Screw — H.27X3

# 1

Align each screw with a pilot hole and partially thread by hand before fully tightening

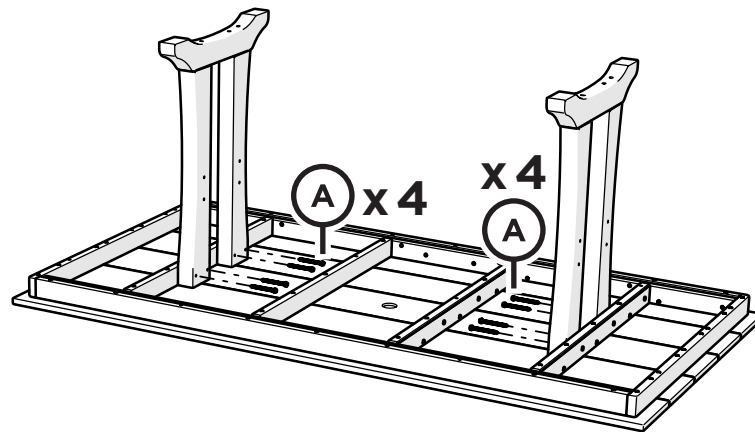

If legs have relaxed during transit, they may be guided into pilot hole alignment



# 2

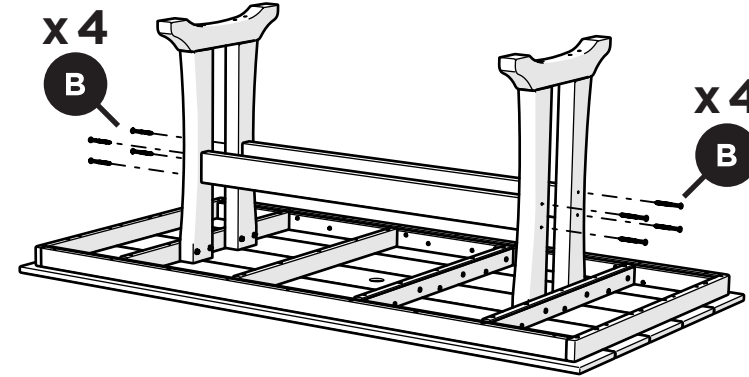

Removable table plug



Something missing?  
Call (833) 665-6300

# POLYWOOD

# POLYWOOD

## Assembly Instructions

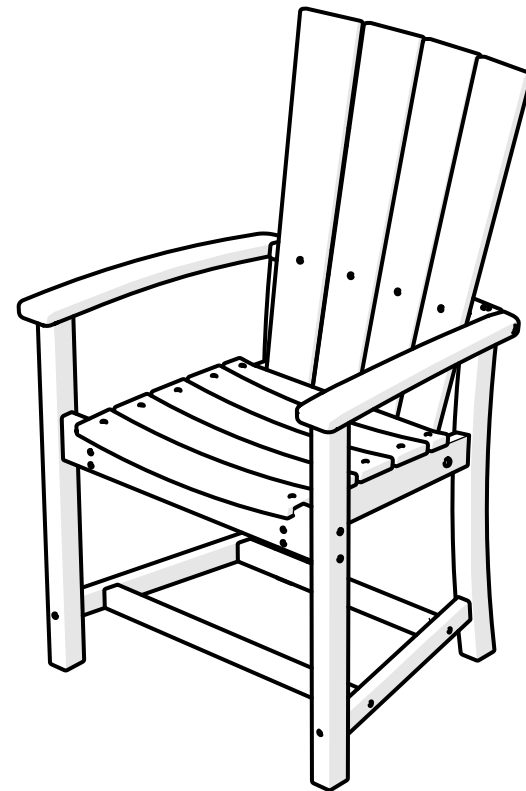

### QLD200, QLD202 Quattro Adirondack Chair



#### 20-year warranty

View our full warranty:

[polywoodoutdoor.com/warranty](http://polywoodoutdoor.com/warranty)



#### Having trouble?

If you have questions or concerns regarding assembly instructions or missing parts, please contact us at [hello@polywoodoutdoor.com](mailto:hello@polywoodoutdoor.com) or (833) 665-6300



#### Cleaning tips

##### For a Quick Clean:

Simply wipe down with soap and water.

##### For a Deep Clean:

Wipe on  $\frac{1}{3}$  bleach and  $\frac{2}{3}$  water solution with a clean cloth and let it sit on the lumber for a few minutes (this will not affect the color). Then, loosen any dirt and debris that may catch in surface grooves with a soft bristle brush; hose down to rinse.

##### For a High-Power Clean:

Use a pressure power washer (not exceeding 1,500 psi) to spray off dirt and debris. Apply a  $\frac{1}{3}$  bleach and  $\frac{2}{3}$  water solution and scrub with a soft-bristle brush. Hose down to rinse.

# Thank You

Thank you for choosing POLYWOOD!  
We hope our furniture helps create a gathering place for you and your loved ones to enjoy for many years to come!



#### Reach Out

Let us know how we're doing:  
[hello@polywoodoutdoor.com](mailto:hello@polywoodoutdoor.com)  
(833) 665-6300



#### Stay Connected

Be the first to hear about new products, giveaways, and more by signing up for our email list: [polywoodoutdoor.com/subscribe](http://polywoodoutdoor.com/subscribe)



#### Watch & Learn

For assembly tips and videos visit:  
[polywoodoutdoor.com/assembly](http://polywoodoutdoor.com/assembly)

#### Share your space

We love to see where our furniture ends up — snap a pic and tag it on Instagram or Facebook for your chance to be featured on our social channels!  
**#polywood #rethinkoutdoor**



[facebook.com/polywoodoutdoor](https://facebook.com/polywoodoutdoor)



[@POLYWOOD](https://instagram.com/POLYWOOD)



[pinterest.com/polywood](https://pinterest.com/polywood)



[youtube.com/polywood](https://youtube.com/polywood)

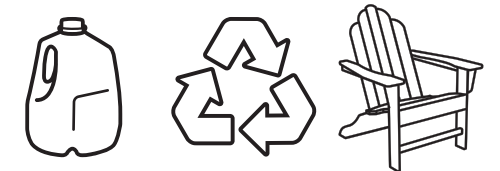

#### Did you know?

POLYWOOD was the original outdoor furniture made from recycled materials.

Learn more about our story:  
[genuinePOLYWOOD.com](http://genuinePOLYWOOD.com)

# TOOLS

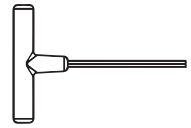

4mm T-handle  
hex key (included)



4mm hex key  
(included)

# PARTS

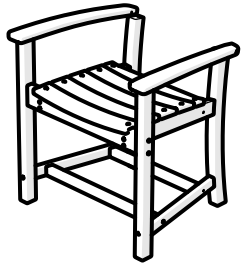
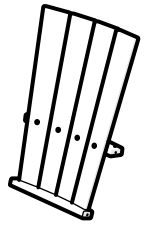

x4

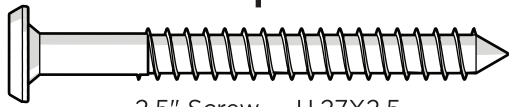

2.5" Screw — H.27X2.5



x2

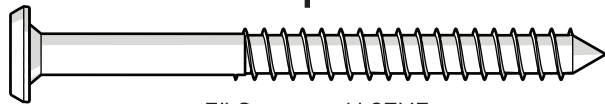

3" Screw — H.27X3

1

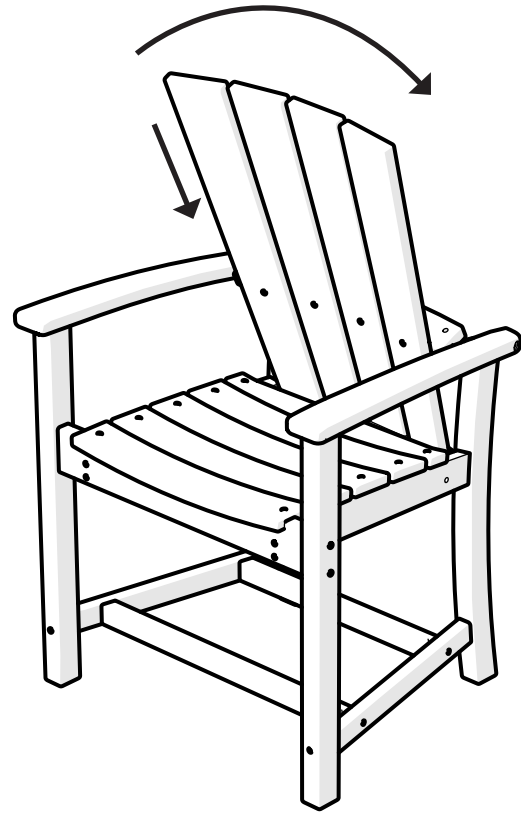

2

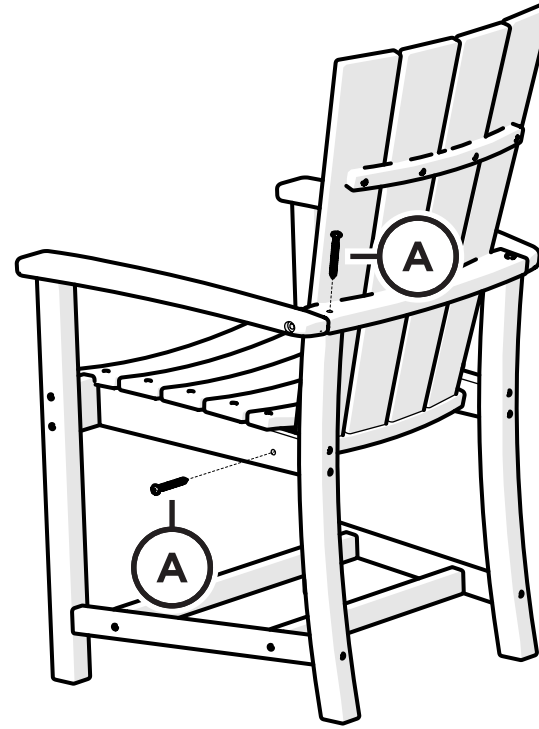

3

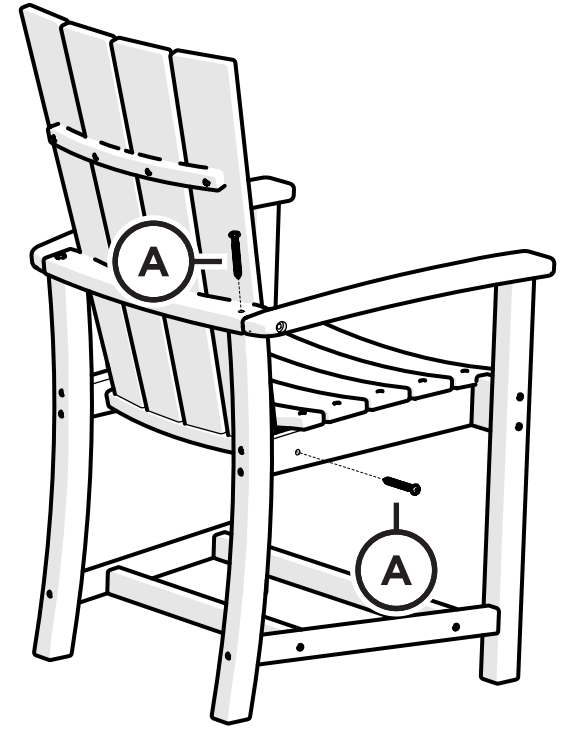

4

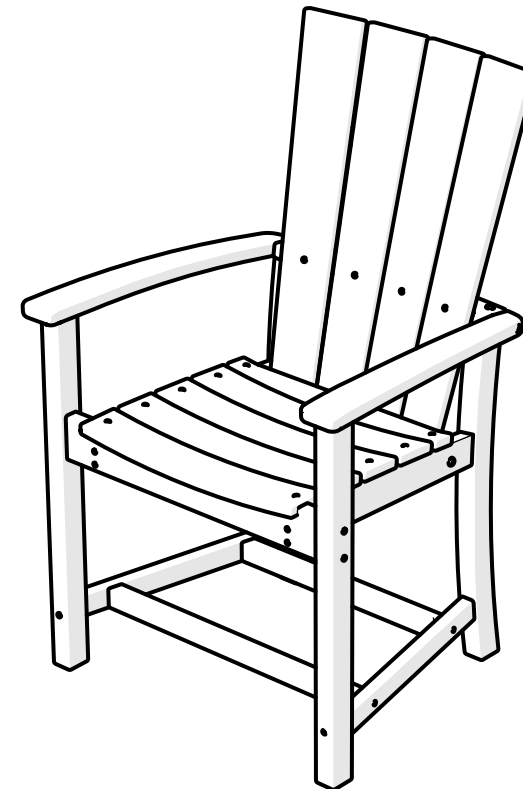
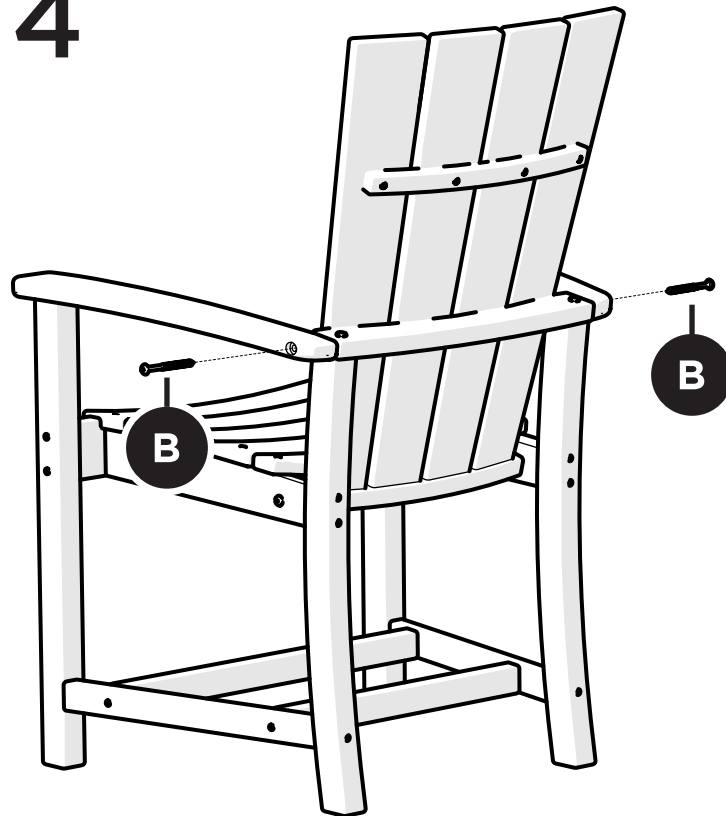

QLD200

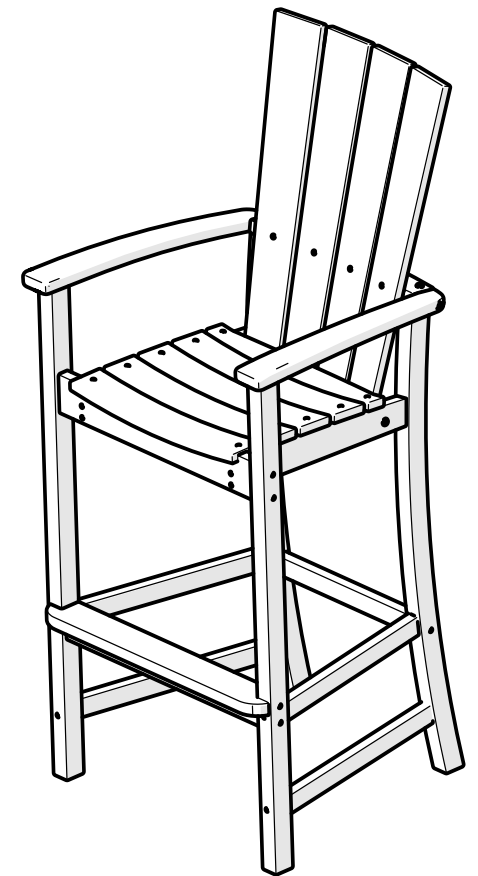

QLD202