



20-year warranty

Great news! Your POLYWOOD warranty is already activated, no need to send anything in. Located on the bottom of each item is a sticker with a serial number. **Please keep this number for your records.**

View our full warranty:
polywood.com/warranty



Having trouble?

If you have questions or concerns regarding assembly instructions or missing parts, please visit help.polywood.com or live chat with our Customer Experience Team on polywood.com.



Cleaning tips

For a Quick Clean:

Simply wipe down with soap and water.

For a Deep Clean:

Wipe on 1/3 bleach and 2/3 water solution with a clean cloth and let it sit on the lumber for a few minutes (this will not affect the color). Then, loosen any dirt and debris that may catch in surface grooves with a soft bristle brush; hose down to rinse.

For a High-Power Clean:

Use a pressure power washer (not exceeding 1,500 psi) to spray off dirt and debris. Apply a 1/3 bleach and 2/3 water solution and scrub with a soft bristle brush. Hose down to rinse.

POLYWOOD®

Assembly Instructions

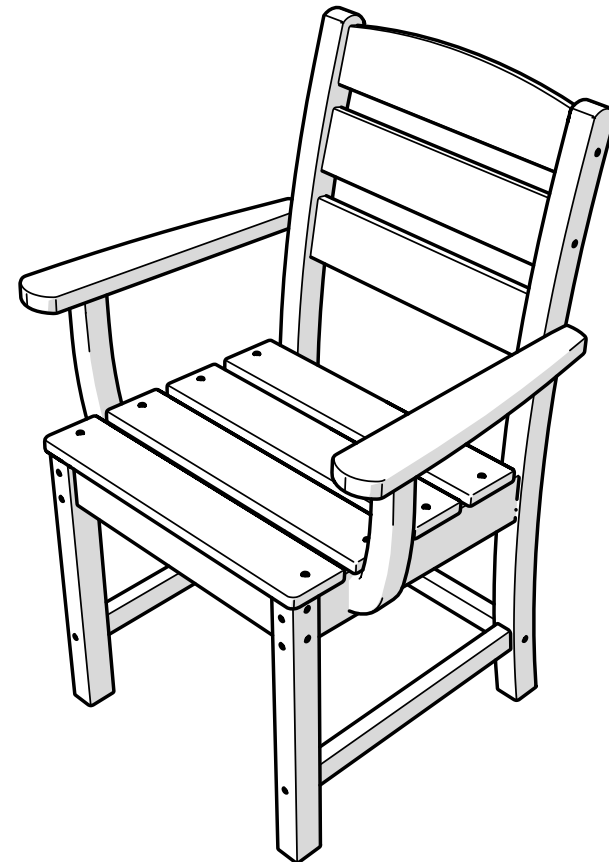

TLD200 Lakeside Dining Arm Chair

polywood.com

Thank You

Thank you for choosing POLYWOOD!
We hope your new furniture helps create a gathering place for you and your loved ones to enjoy for many years to come!



Join the POLYWOOD Owner's Community

Sign up at:
polywood.com/welcome

As a POLYWOOD Owner, you'll be among the first to access exclusive information about new product launches, special promotions, and giveaways.



Reach Out

Questions? Please contact us:
Live Chat on polywood.com
hello@polywood.com
(855) 935-5550



Watch & Learn

For assembly tips and videos visit:
polywood.com/assembly

Share your space

We love to see where your furniture ends up — snap a pic and tag it on Instagram or Facebook for your chance to be featured on our social channels!
#polywood #loveyouroutdoors



facebook.com/polywoodoutdoor



[@POLYWOOD](https://instagram.com/POLYWOOD)



pinterest.com/polywood



youtube.com/polywood



Did you know?

On average, POLYWOOD recycles up to 400,000 milk jugs a day!

Learn more about our story:
genuinePOLYWOOD.com

TOOLS

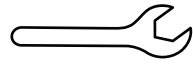

3/8" wrench
(not included)

PARTS

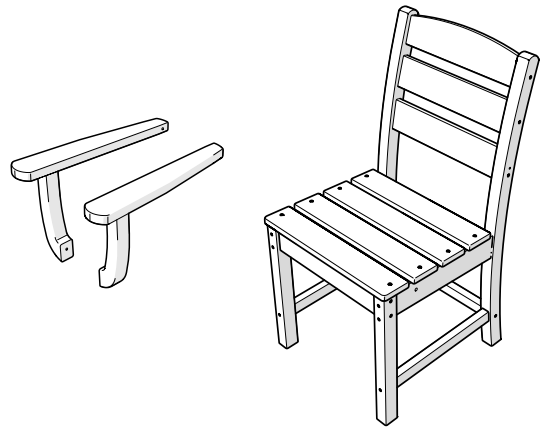

A x2

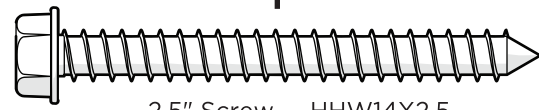

2.5" Screw — HHW14X2.5

B x2

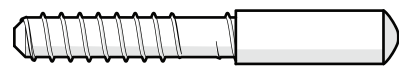

Cap Dowel Screw — HD.25X2+P11420

Something missing?
Visit help.polywood.com

1

Twist dowel screw into arm until
finger-tight, remove protective cap

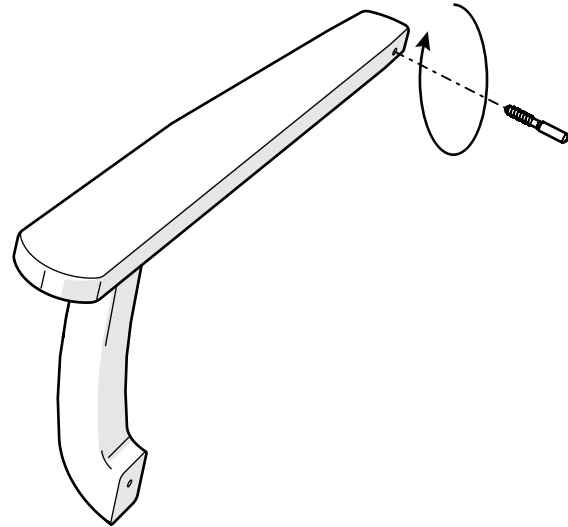

2

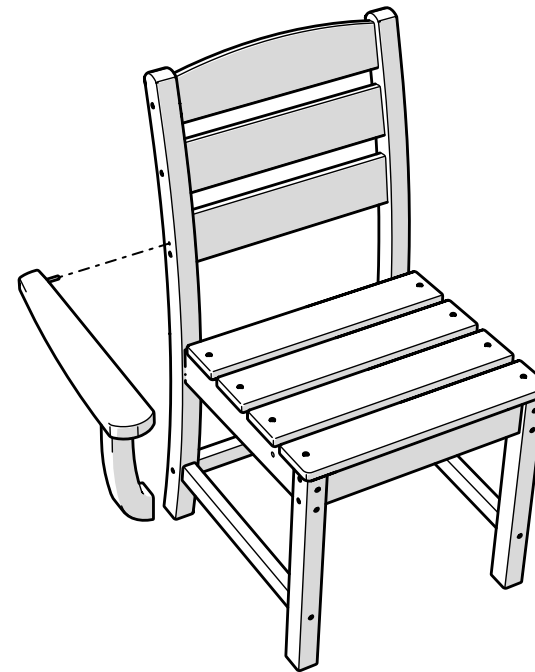

3

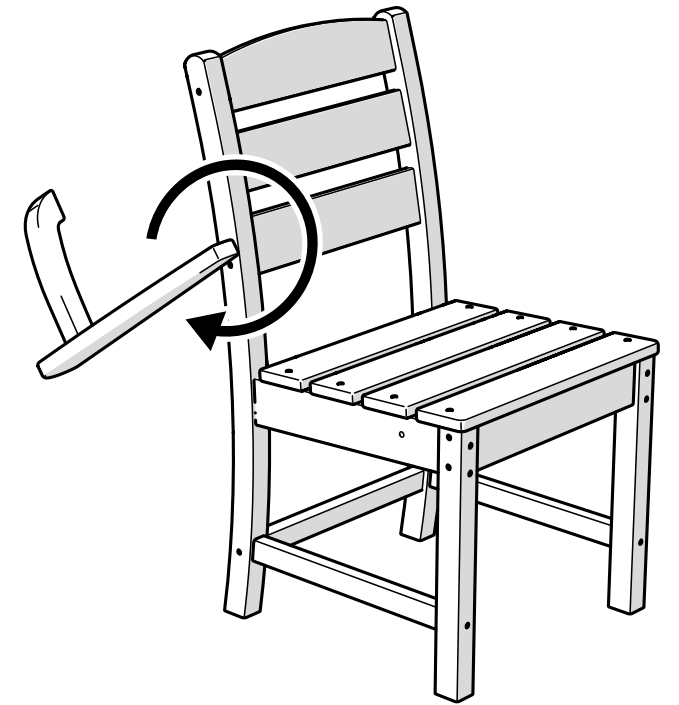

4

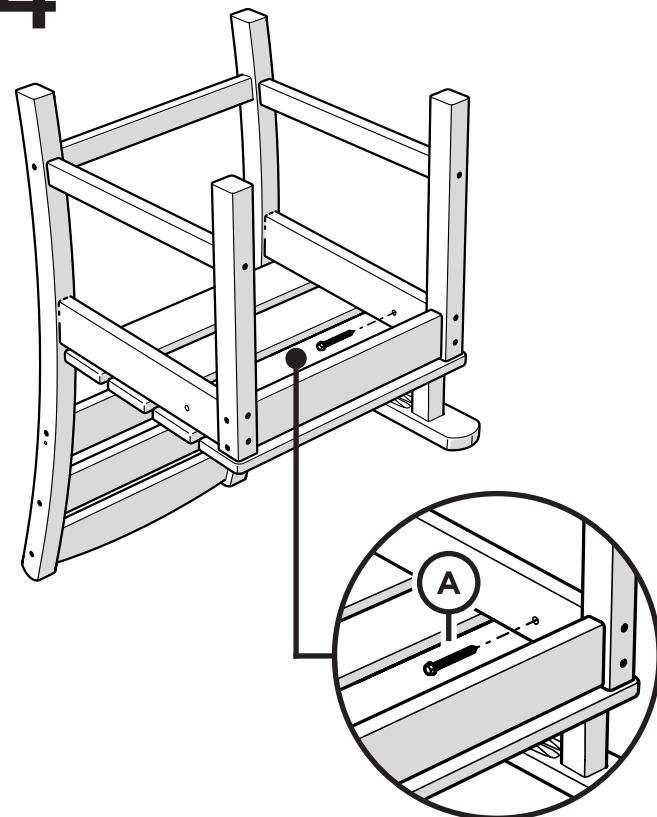

5

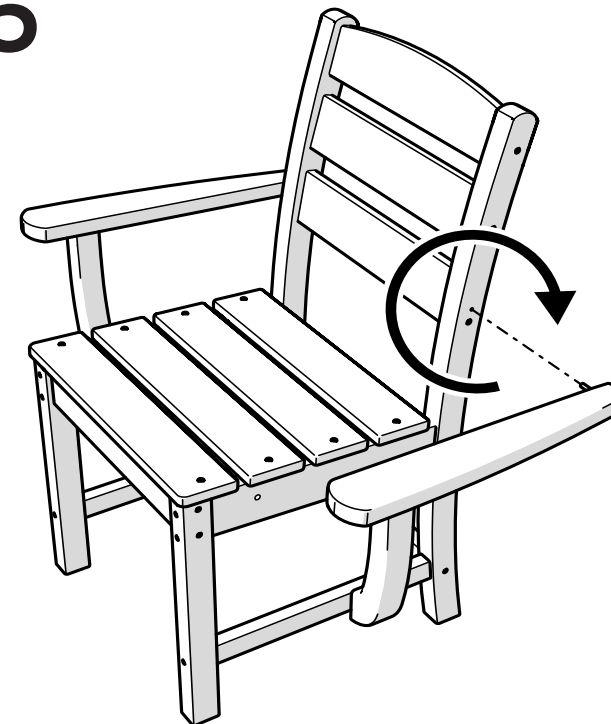

Repeat Steps 1 Thru 4
On Opposite Side

POLYWOOD®