

POLYWOOD

Assembly Instructions

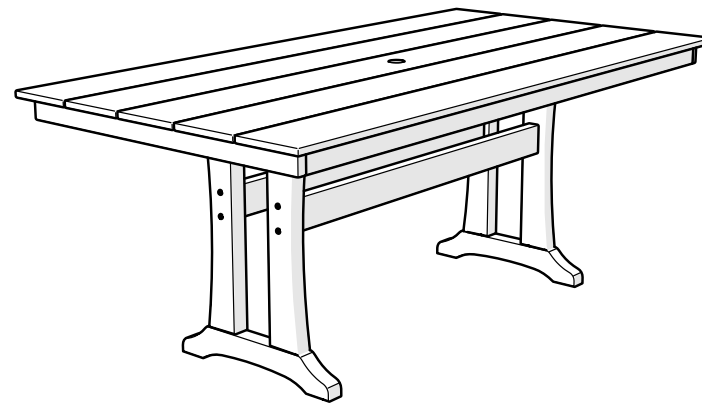

**L1D83, L1R83,
L1B83**

**For Use With Rectangle
Plank Tables-PL83**



20-year warranty

View our full warranty:

polywoodoutdoor.com/warranty



Having trouble?

If you have questions or concerns regarding assembly instructions or missing parts, please contact us at hello@polywoodoutdoor.com or (833) 665-6300



Cleaning tips

For a Quick Clean:

Simply wipe down with soap and water.

For a Deep Clean:

Wipe on $\frac{1}{3}$ bleach and $\frac{2}{3}$ water solution with a clean cloth and let it sit on the lumber for a few minutes (this will not affect the color). Then, loosen any dirt and debris that may catch in surface grooves with a soft bristle brush; hose down to rinse.

For a High-Power Clean:

Use a pressure power washer (not exceeding 1,500 psi) to spray off dirt and debris. Apply a $\frac{1}{3}$ bleach and $\frac{2}{3}$ water solution and scrub with a soft-bristle brush. Hose down to rinse.

Thank You

Thank you for choosing POLYWOOD!
We hope our furniture helps create a gathering place for you and your loved ones to enjoy for many years to come!



Reach Out

Let us know how we're doing:
hello@polywoodoutdoor.com
(833) 665-6300



Stay Connected

Be the first to hear about new products, giveaways, and more by signing up for our email list: polywoodoutdoor.com/subscribe



Watch & Learn

For assembly tips and videos visit:
polywoodoutdoor.com/assembly

Share your space

We love to see where our furniture ends up — snap a pic and tag it on Instagram or Facebook for your chance to be featured on our social channels!

#polywood #rethinkoutdoor



facebook.com/polywoodoutdoor



[@POLYWOOD](https://www.instagram.com/POLYWOOD)



pinterest.com/polywood



youtube.com/polywood

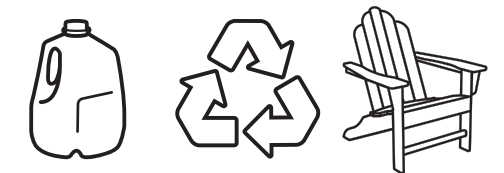

Did you know?

POLYWOOD was the original outdoor furniture made from recycled materials.

Learn more about our story:
genuinePOLYWOOD.com

TOOLS

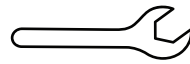

3/8" wrench
(not included)

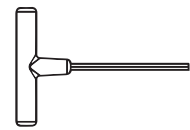

4mm T-handle
hex key (included)

PARTS

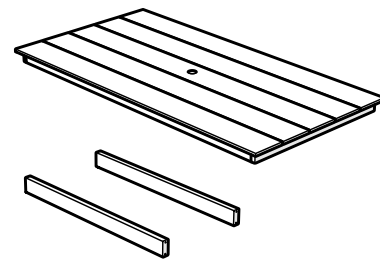

Separate box

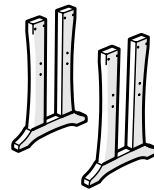

A x 8

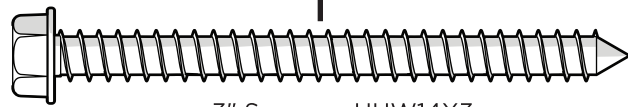

3" Screw — HHW14X3

B x 8

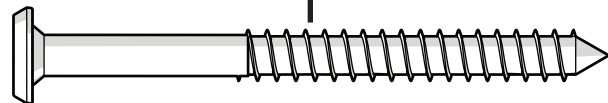

3" Screw — H.27X3

1

Align each screw with a pilot hole and partially thread by hand before fully tightening

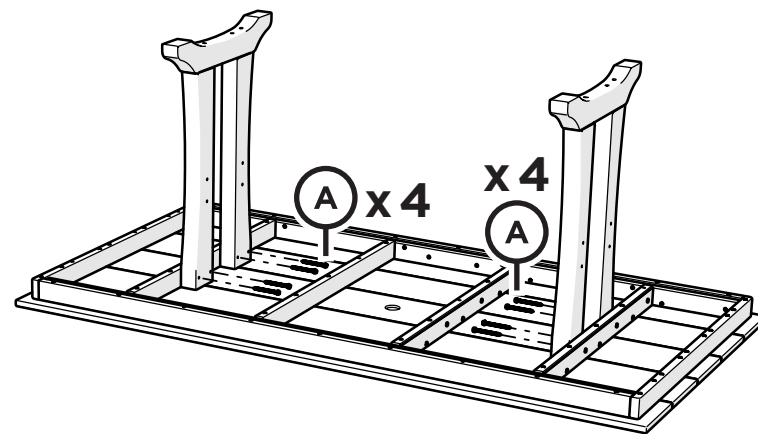

If legs have relaxed during transit, they may be guided into pilot hole alignment

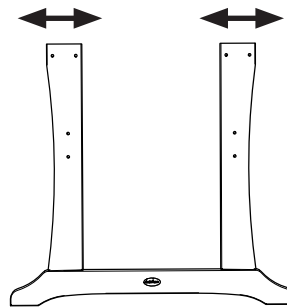

2

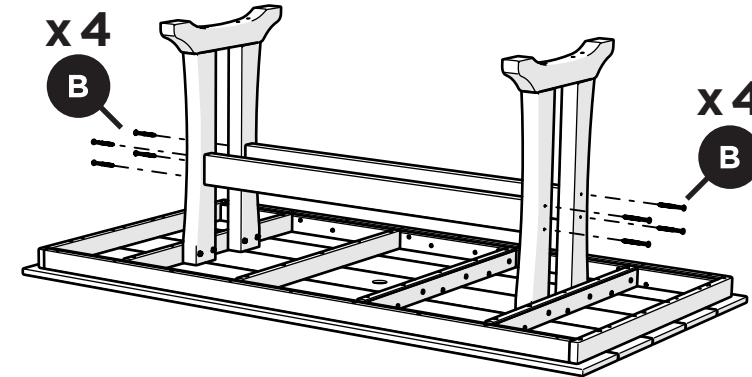

Removable table plug

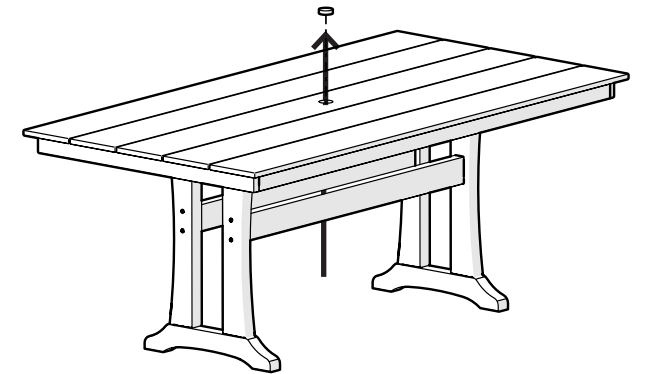

Something missing?
Call (833) 665-6300

POLYWOOD



20-Year Warranty

Great news! Your POLYWOOD warranty is already activated, no need to send anything in. Located on the bottom of each item is a sticker with a serial number. **Please keep this number for your records.**

View our full warranty:
polywood.com/warranty



Cleaning Tips

For a Quick Clean:

Simply wipe down with soap and water.

For a Deep Clean:

Wipe on 1/3 bleach and 2/3 water solution with a clean cloth and let it sit on the lumber for a few minutes (this will not affect the color). Then, loosen any dirt and debris that may catch in surface grooves with a soft bristle brush; hose down to rinse.

For a High-Power Clean:

Use a pressure power washer (not exceeding 1,500 psi) to spray off dirt and debris. Apply a 1/3 bleach and 2/3 water solution and scrub with a soft bristle brush. Hose down to rinse.

POLYWOOD®

Assembly Instructions

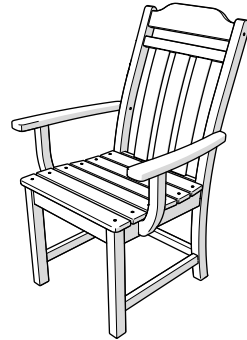

CLTGD240
Cottage Dining Arm Chair

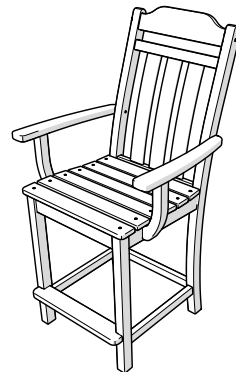

CLTGD241
Cottage Counter Arm Chair

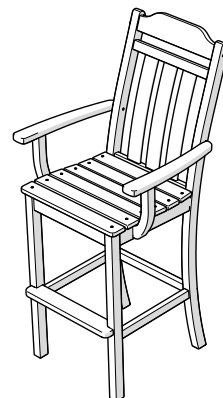

CLTGD242
Cottage Bar Arm Chair

polywood.com

Thank You

Thank you for choosing POLYWOOD!
We hope your new furniture helps create a gathering place for you and your loved ones to enjoy for many years to come!



Join the POLYWOOD Community

Sign up at:
polywood.com/welcome

You'll be the first to hear about new product launches, giveaways, special offers, and more!



We're Always Here For You

If you have questions regarding assembly instructions, warranty claims, or missing parts, please visit our Help Center at
help.polywood.com



Watch & Learn

For assembly tips and videos visit:
polywood.com/assembly

Share Your Space

We love to see your furniture at home — share a photo or video and tag us for your chance to be featured!

#polywood



[@POLYWOOD](https://www.instagram.com/POLYWOOD)



pinterest.com/polywood



youtube.com/polywood



facebook.com/polywoodoutdoor

Join thousands of fans in our Outdoor Living Community!

facebook.com/groups/polywoodoutdoorliving

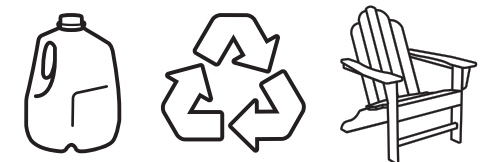

Did You Know?

Our long-lasting furniture is made using plastics that could otherwise pollute oceans and overwhelm landfills — and it can also be recycled when the time comes. Better for the planet, better for all.

Learn more about our story:
genuinePOLYWOOD.com

TOOLS

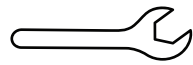

3/8" wrench
(not included)

PARTS

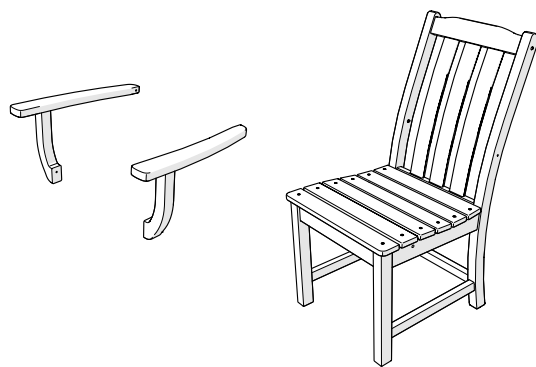

A x 2

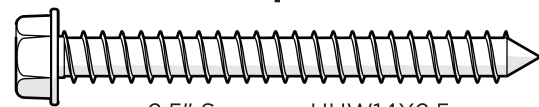

2.5" Screw — HHW14X2.5

B x 2

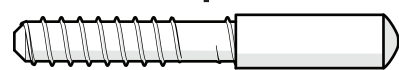

Cap Dowel Screw — HD.25X2+P11420

Something missing?
Visit help.polywood.com

1

Twist dowel screw into arm until
finger-tight, remove protective cap

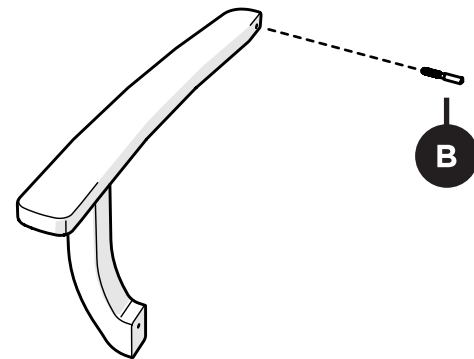

2

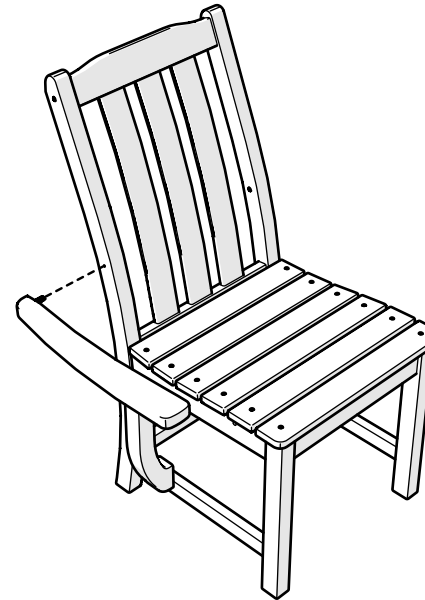

3

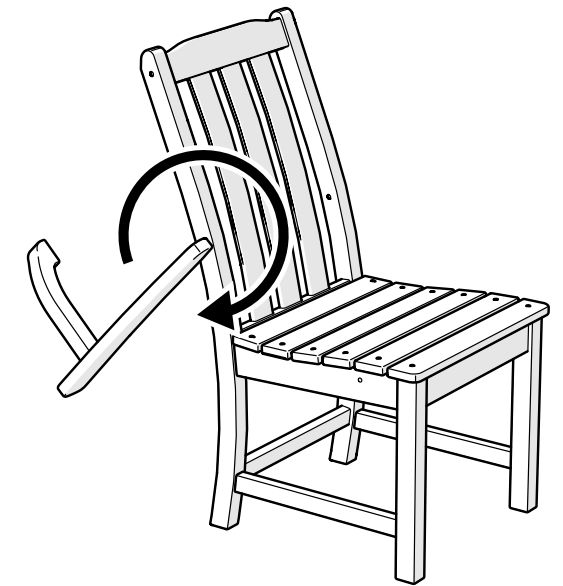

4

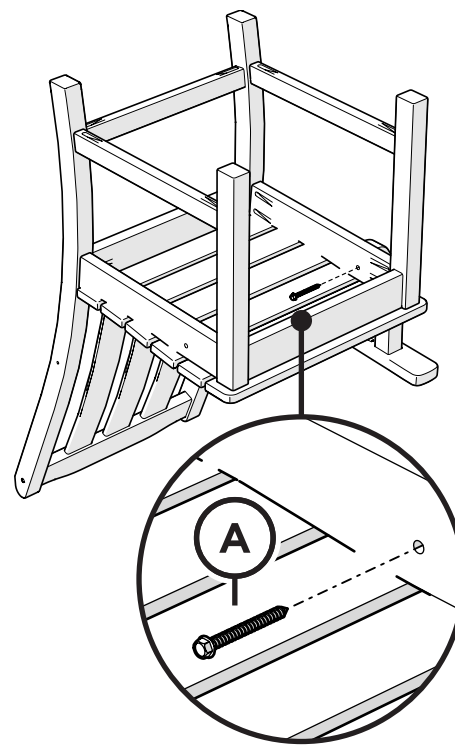

Repeat Steps 1 Thru 4
On Opposite Side



Remove protective plastic
film from the logo medallion.

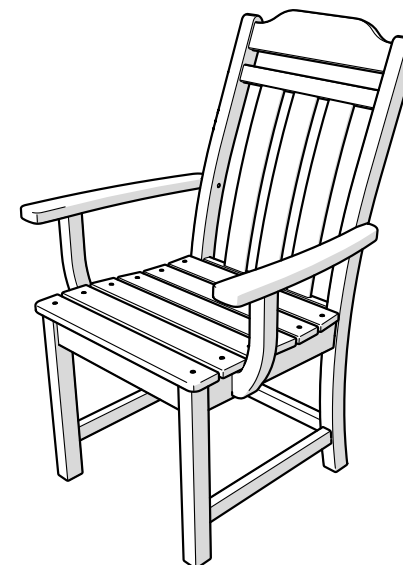

CLTGD240

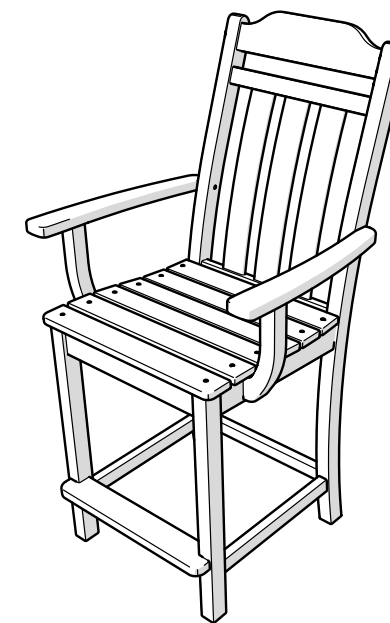

CLTGD241

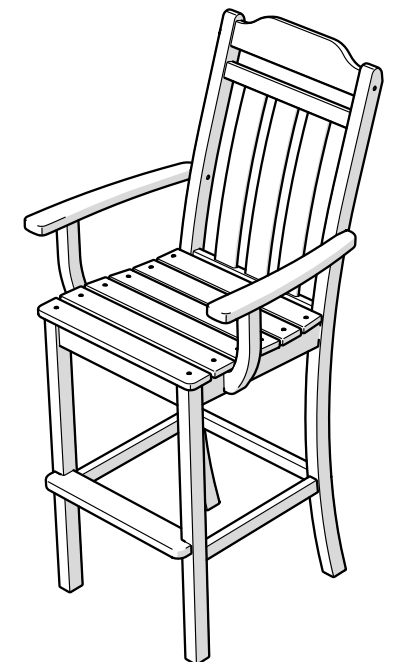

CLTGD242