



# POLYWOOD

## Assembly Instructions



### Having Trouble?

If you have questions or concerns regarding assembly instructions or missing parts, please contact us at **(833) 665-6300** or email [support@polywoodoutdoor.com](mailto:support@polywoodoutdoor.com)



### Share your space

We love to see where our furniture ends up — snap a pic and share it on Instagram or Facebook!  
**#polywood**



### Watch & Learn

For assembly videos and more, visit [youtube.com/polywood](https://www.youtube.com/polywood)

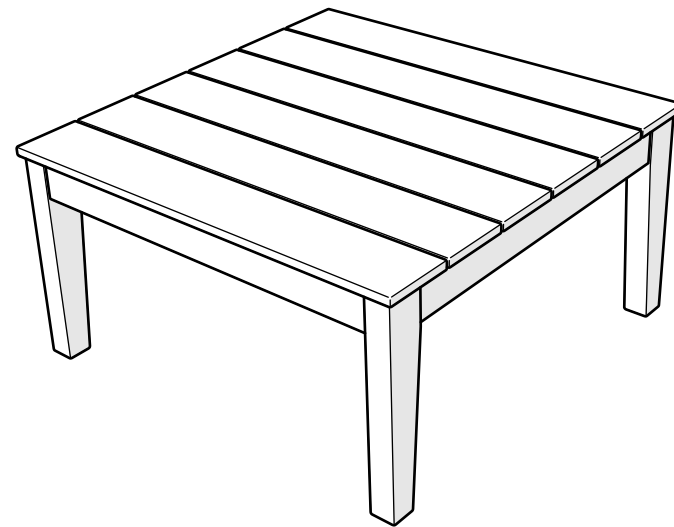

## MNT36 Newport 36" Conversation Table

### 20-Year Warranty

To view our full warranty, please visit [polywoodoutdoor.com/warranty](https://polywoodoutdoor.com/warranty)

Easily register your product using one of the methods below:

**Text POLYWOOD to 71403**  
Receive a link to register online

— or —

**Register on our website**  
[register.polywoodoutdoor.com](https://register.polywoodoutdoor.com)

— or —

**Send a Picture**  
Take a photo of the icon below and text it to 71403 (US only)

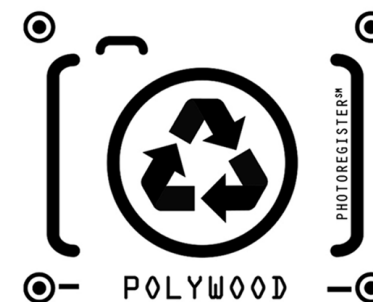

### Cleaning Tips

Even POLYWOOD gets dirty — here are some ways to help keep it clean:

**For a quick clean:**  
Simply wipe down with soap and water.

**For a deeper clean:**  
You'll need:  
» 1/3 bleach and 2/3 water solution  
» clean cloth  
» soft bristle brush  
Wipe on solution with your cloth and let it sit on the lumber for a few minutes (this will not affect the color). Then, loosen any dirt and debris that may catch in surface grooves with a soft bristle brush; hose down to rinse.

## TOOLS



3/8" wrench  
(not included)

## PARTS

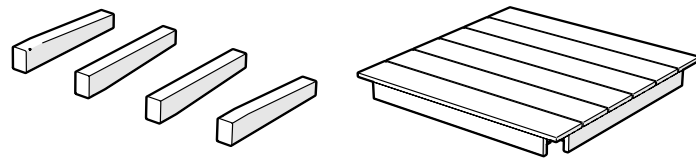

**A** x 4

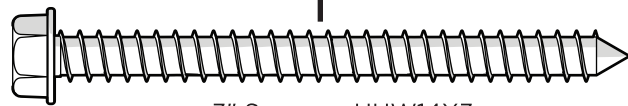

3" Screw — HHW14X3

# 1

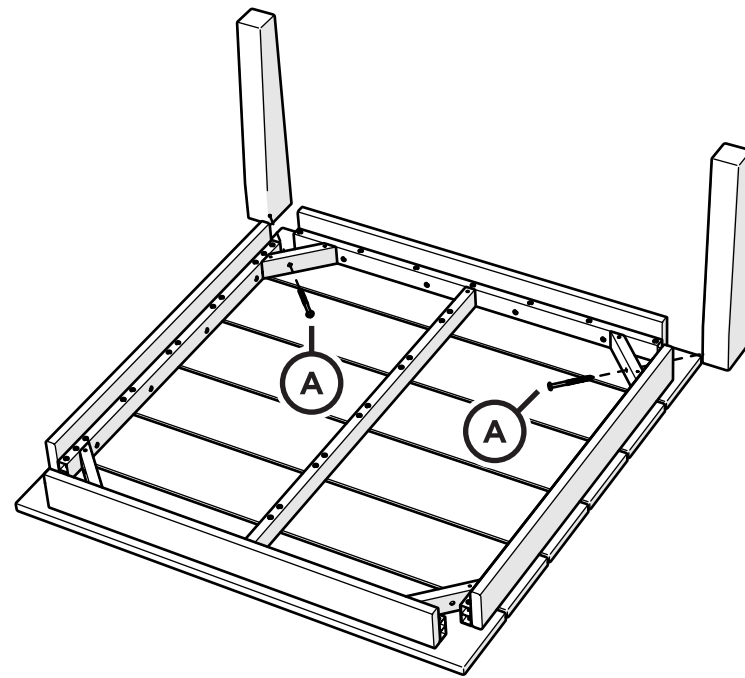

# 2

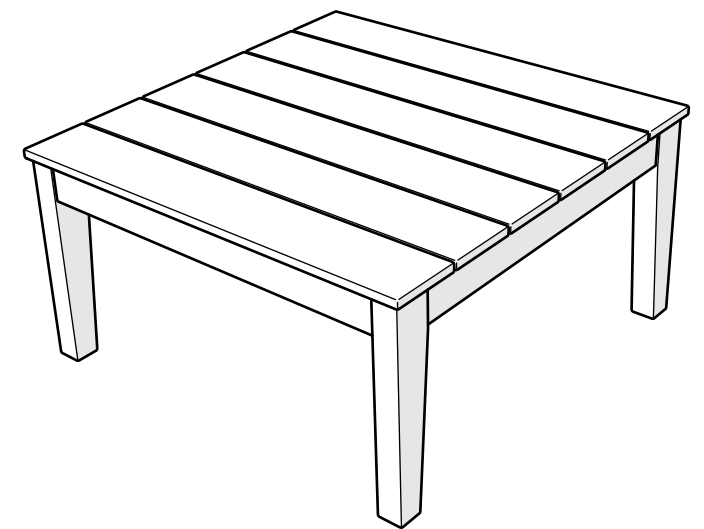
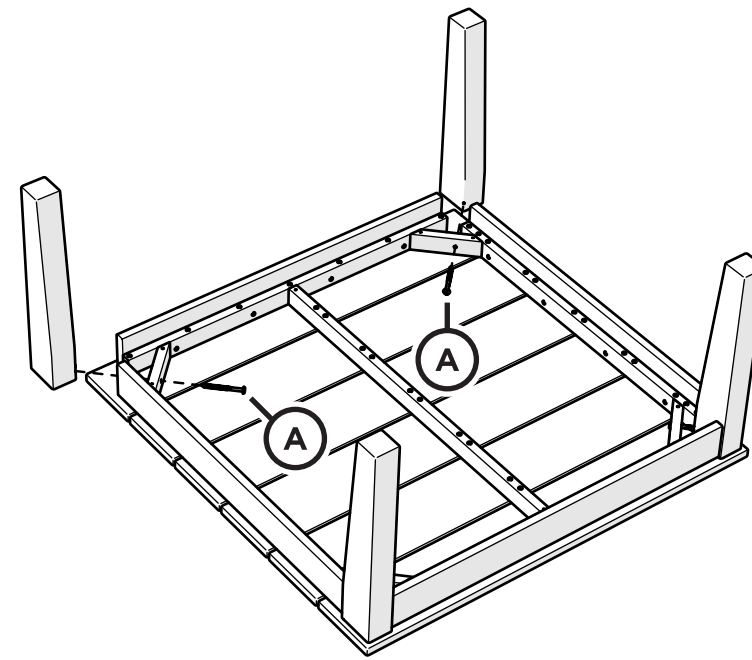

Something missing?  
Call (833) 665-6300

# POLYWOOD



# POLYWOOD

## Assembly Instructions



### Having Trouble?

If you have questions or concerns regarding assembly instructions or missing parts, please contact us at **(833) 665-6300** or email [support@polywoodoutdoor.com](mailto:support@polywoodoutdoor.com)



### Share your space

We love to see where our furniture ends up — snap a pic and share it on Instagram or Facebook!  
**#polywood**



### Watch & Learn

For assembly videos and more, visit [youtube.com/polywood](https://www.youtube.com/polywood)

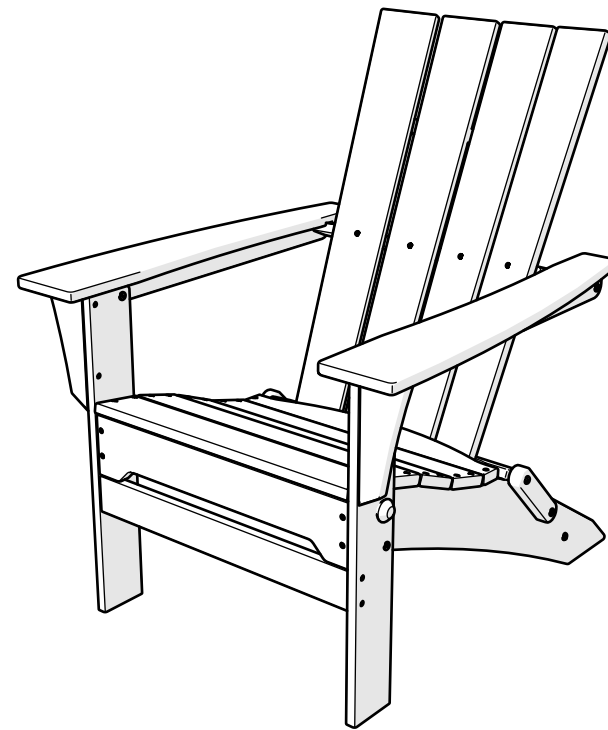

## QNA110 Quattro Folding Adirondack Chair

### 20-Year Warranty

To view our full warranty, please visit [polywoodoutdoor.com/warranty](https://polywoodoutdoor.com/warranty)

Easily register your product using one of the methods below:

**Text POLYWOOD to 71403**  
Receive a link to register online

— or —

**Register on our website**  
[register.polywoodoutdoor.com](https://register.polywoodoutdoor.com)

— or —

**Send a Picture**  
Take a photo of the icon below and text it to 71403 (US only)

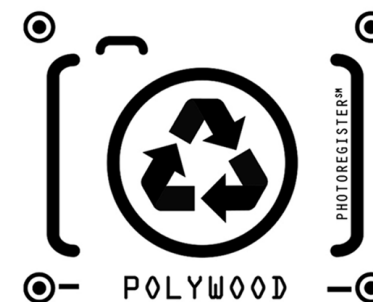

### Cleaning Tips

Even POLYWOOD gets dirty — here are some ways to help keep it clean:

#### For a quick clean:

Simply wipe down with soap and water.

#### For a deeper clean:

You'll need:

- » 1/3 bleach and 2/3 water solution
- » clean cloth
- » soft bristle brush

Wipe on solution with your cloth and let it sit on the lumber for a few minutes (this will not affect the color). Then, loosen any dirt and debris that may catch in surface grooves with a soft bristle brush; hose down to rinse.

## TOOLS

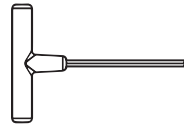

4mm T-handle  
hex key (included)

## PARTS

**A** x 2

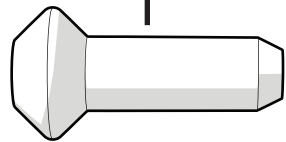

Adirondack Pin - HDPE

**B** x 2

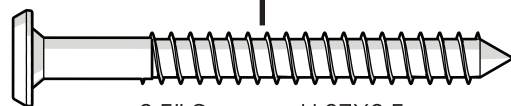

2.5" Screw — H.27X2.5

1

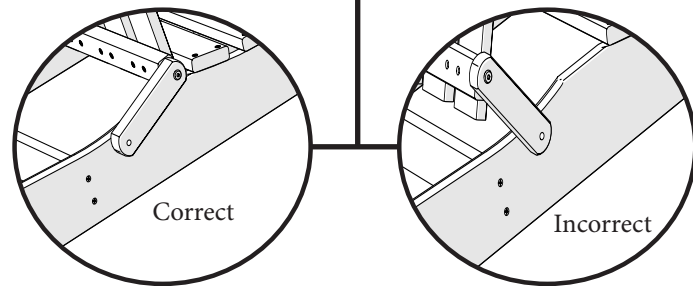
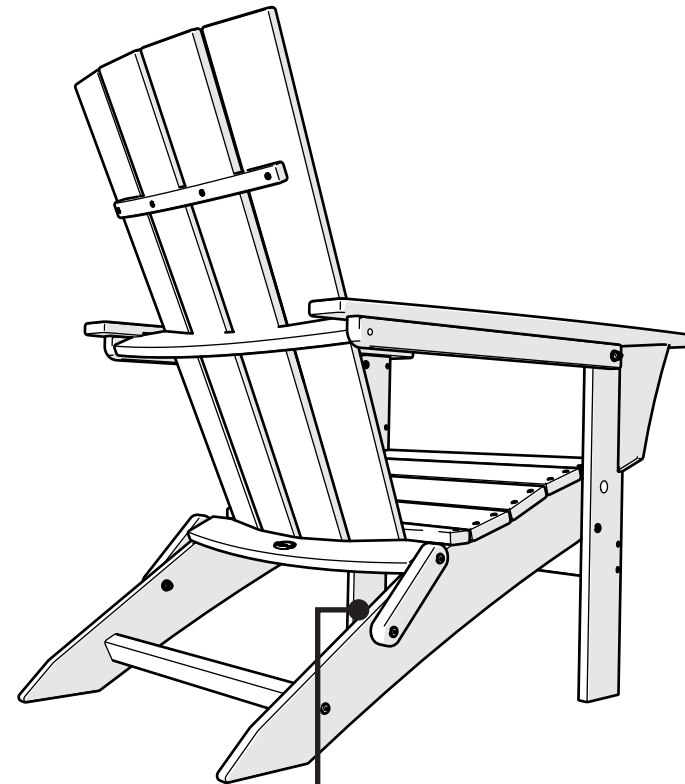

2

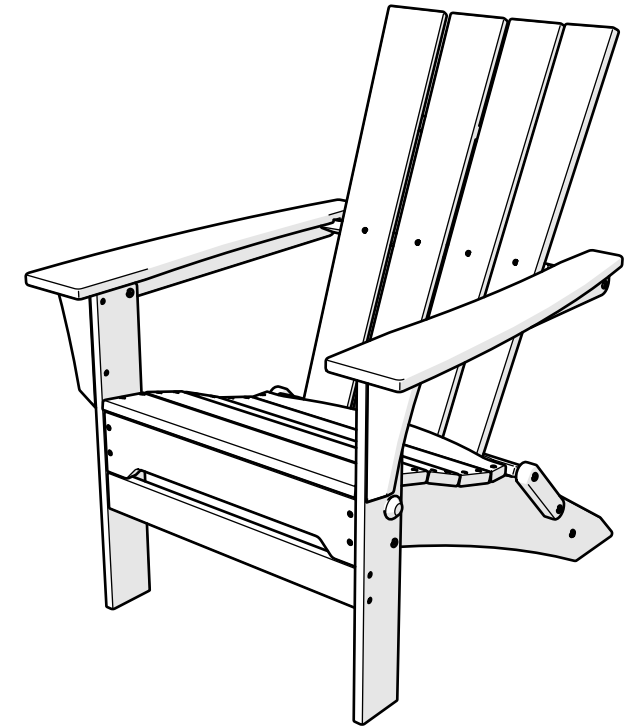
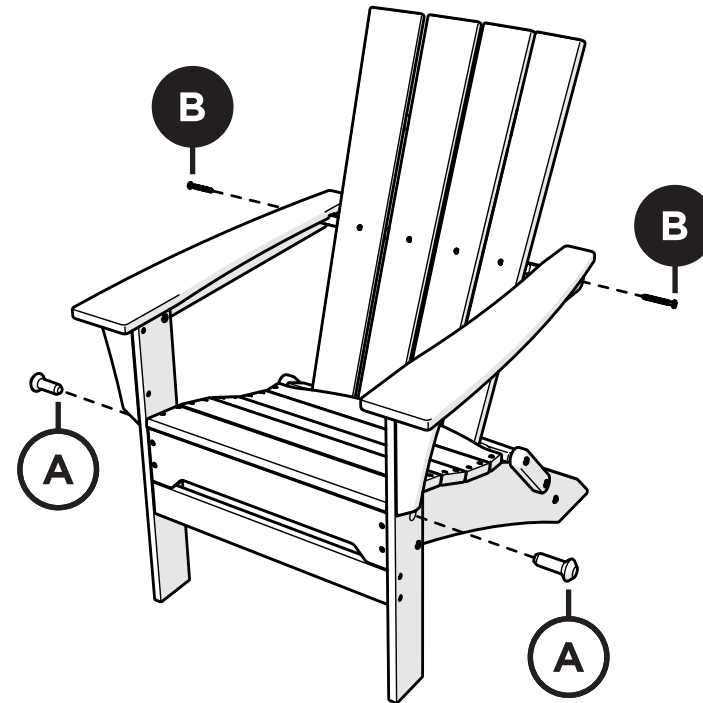

Something missing?  
Call (833) 665-6300

POLYWOOD