



# POLYWOOD

## Assembly Instructions



### Having Trouble?

If you have questions or concerns regarding assembly instructions or missing parts, please contact us at (877) 457-3284 or email [support@polywoodoutdoor.com](mailto:support@polywoodoutdoor.com)



### Share your space

We love to see where our furniture ends up — snap a pic and share it on Instagram or Facebook!  
#polywood



### Watch & Learn

For assembly videos and more, visit [youtube.com/polywood](https://youtube.com/polywood)

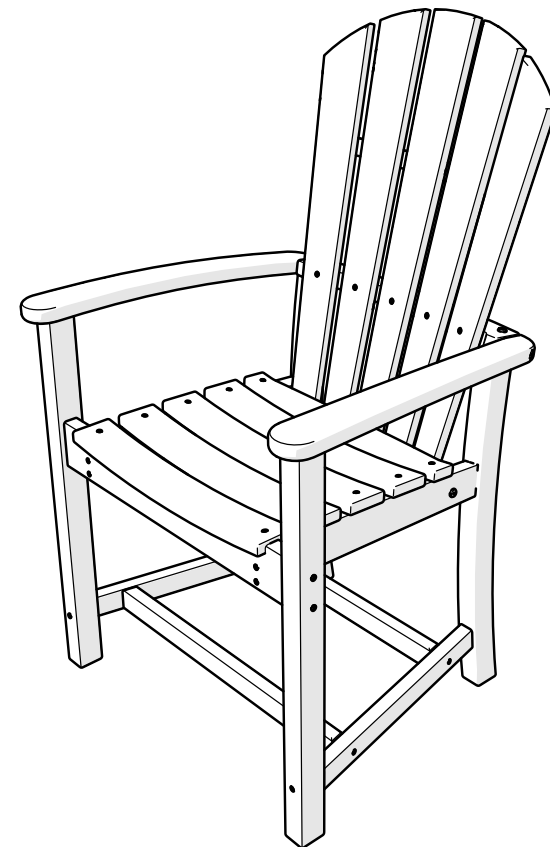

## HND200, HND202 Palm Coast Adirondack Chair

### 20-Year Warranty

To view our full warranty, please visit [polywoodoutdoor.com/warranty](https://polywoodoutdoor.com/warranty)

Easily register your product using one of the methods below:

**Text POLYWOOD to 71403**  
Receive a link to register online

— or —

**Register on our website**  
[register.polywoodoutdoor.com](https://register.polywoodoutdoor.com)

— or —

**Send a Picture**  
Take a photo of the icon below and text it to 71403 (US only)



### Cleaning Tips

Even POLYWOOD gets dirty — here are some ways to help keep it clean:

#### For a quick clean:

Simply wipe down with soap and water.

#### For a deeper clean:

You'll need:

- » 1/3 bleach and 2/3 water solution
- » clean cloth
- » soft bristle brush

Wipe on solution with your cloth and let it sit on the lumber for a few minutes (this will not affect the color). Then, loosen any dirt and debris that may catch in surface grooves with a soft bristle brush; hose down to rinse.

# TOOLS

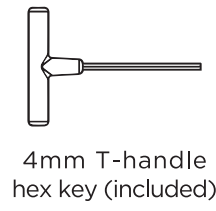

# PARTS

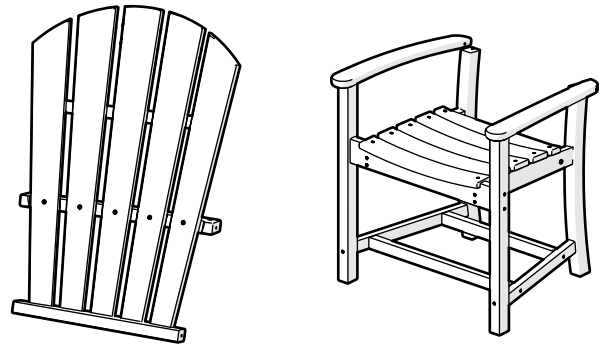

**A** x4

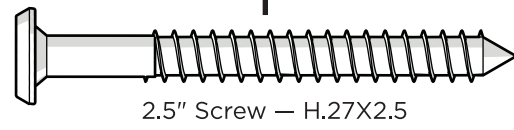

**B** x2

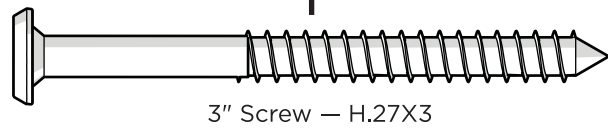

**1**

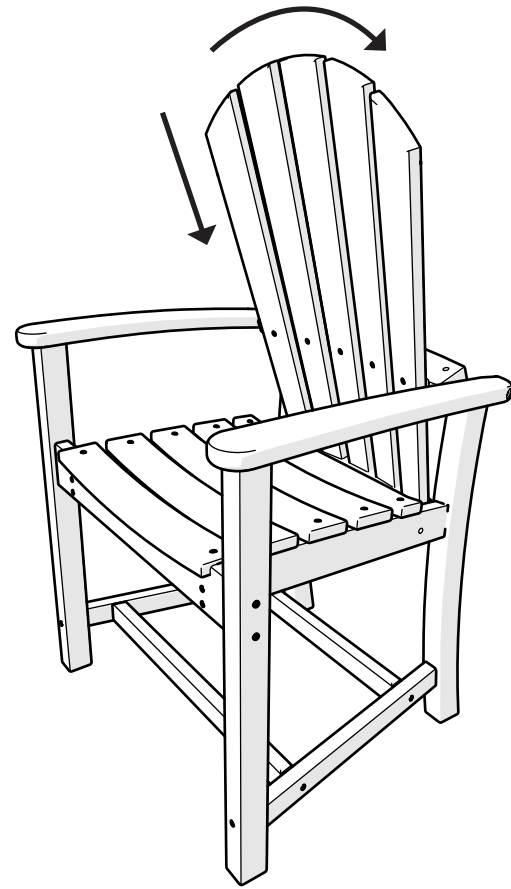

**2**

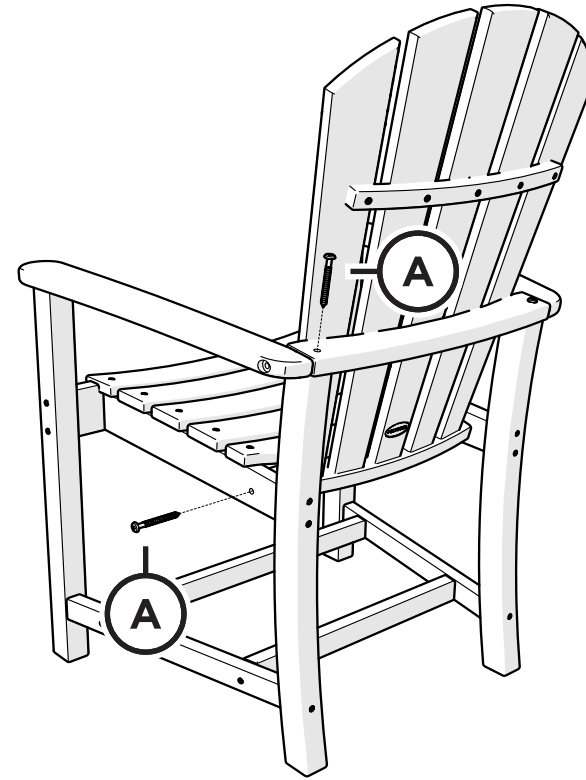

**3**

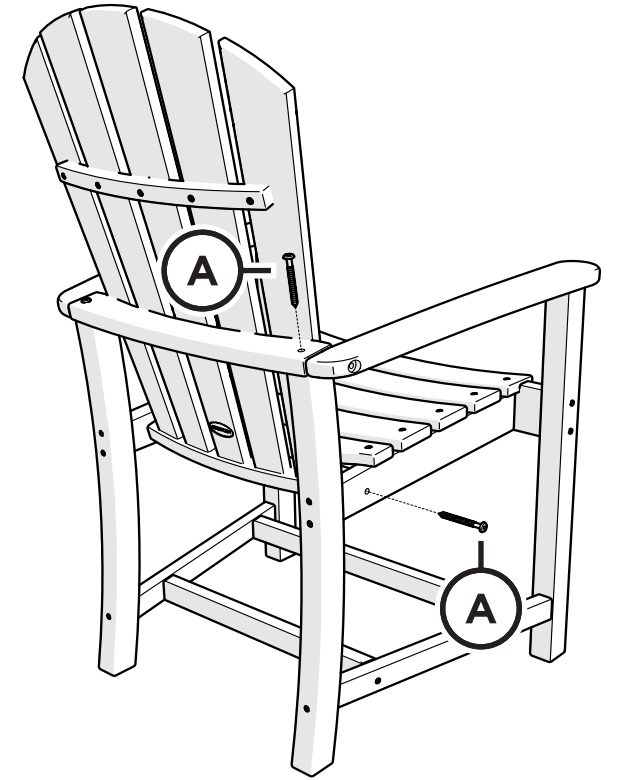

**4**

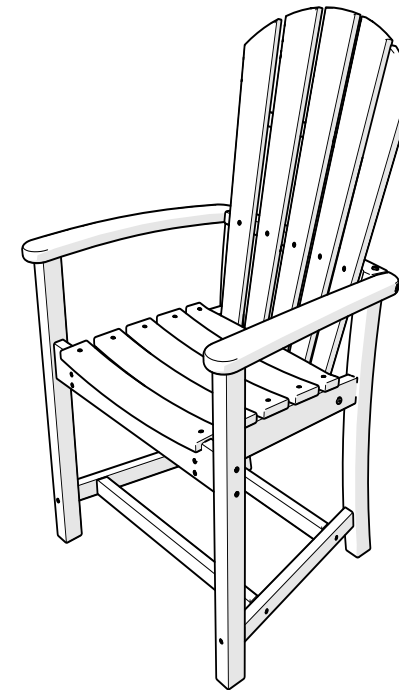
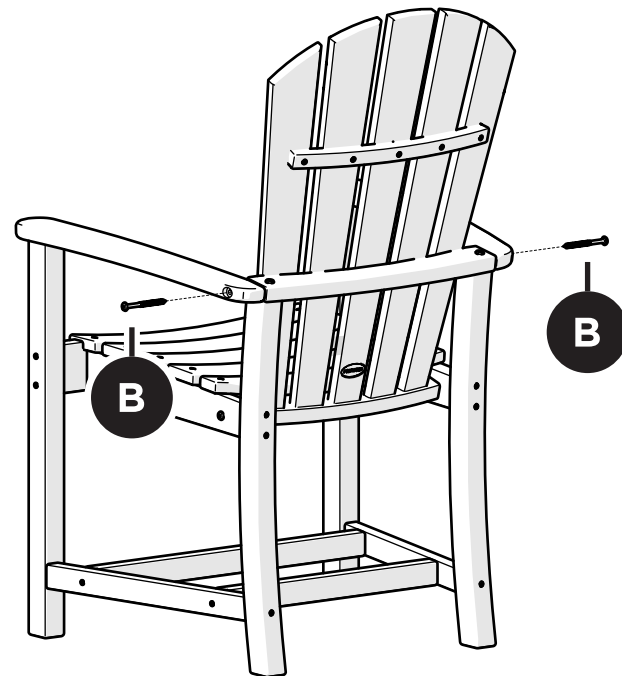

HND200

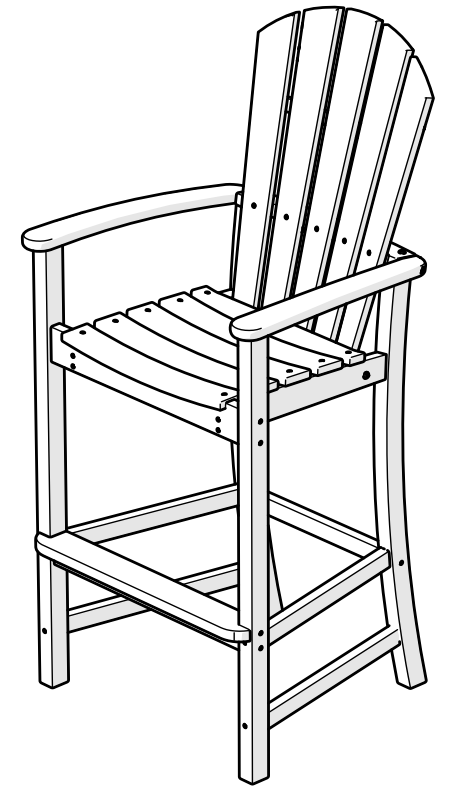

HND202



All Weather Furnishings

**Model:**

RT448

- (1) Table top
- (2) Leg Assemblies
- (2) Brace
- (1) Hardware pack

**TOOLS NEEDED**

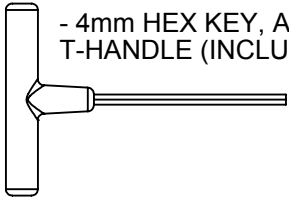

- 4mm HEX KEY, ALLEN, T-HANDLE (INCLUDED)

- 3/8" Wrench (not included)

**Step 1**

Attach leg assemblies to table top using (8) 2-1/2" chair bolts.

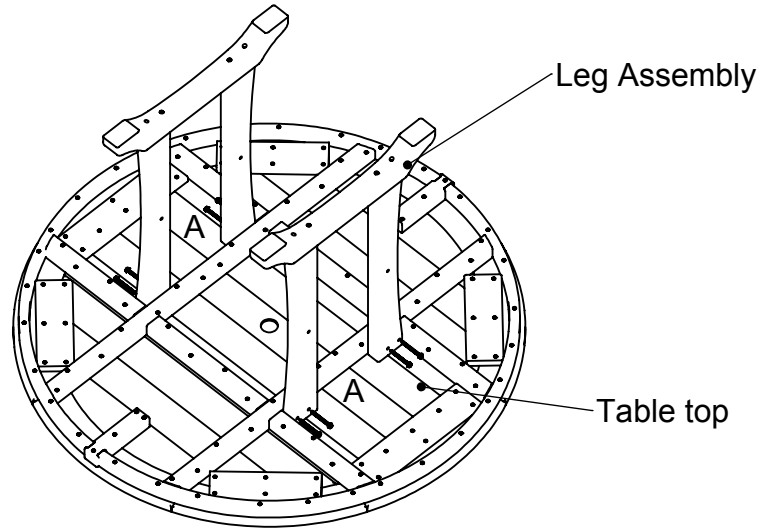

**Step 2**

Attach braces to leg assemblies using (4) 2-1/2" screws.

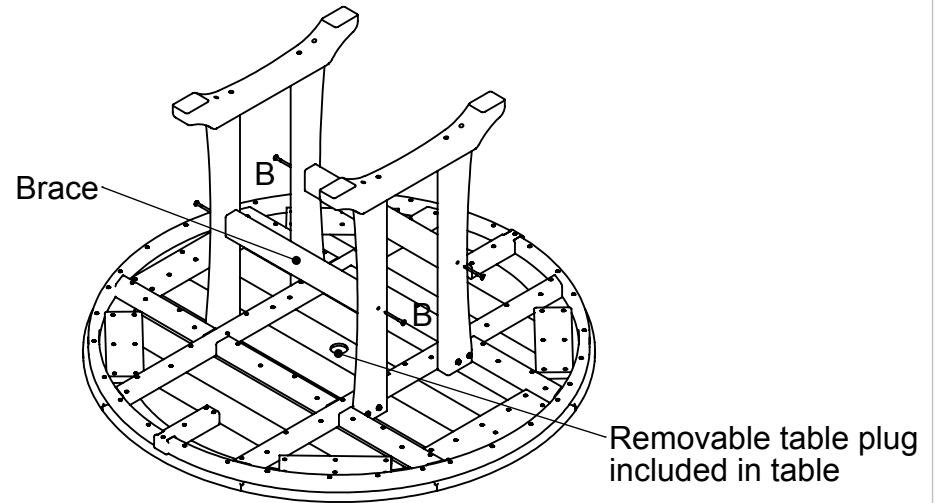

Qty.	Description
8	A - 14 X 2.50 HEX WASHER T-A ALCHM
4	B - .273 X 2.50 SOCKET WAFER A

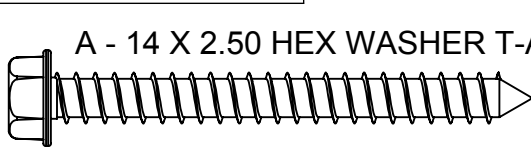

# POLYWOOD®

*All Weather Furnishings*

Join the POLYWOOD® Community

*Share in the love of outdoor living, recycling, and more...*



POLYWOOD



@POLYWOODINC



[youtube.com/polywood](https://youtube.com/polywood)



POLY-WORLD  
Blog



POLYWOOD



To view our full warranty, please visit the warranty page on our website at [polywoodinc.com/resources](https://polywoodinc.com/resources).

If you have questions or concerns regarding assembly instructions or missing parts, please contact us at (877) 457-3284 or email [support@polywoodinc.com](mailto:support@polywoodinc.com)